

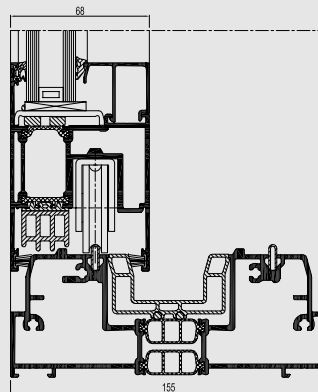

CP 155

Sophistication for quality and insulation

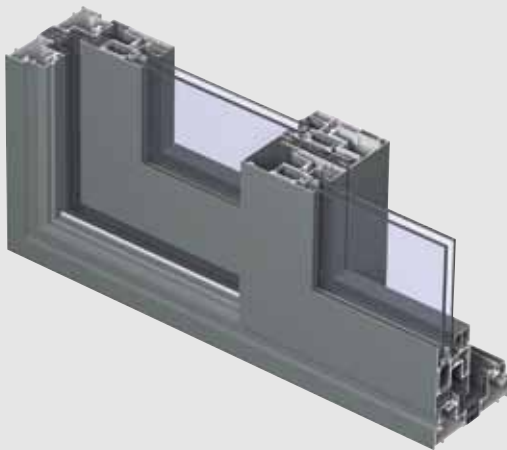

CP 155 is a premium insulated sliding system with elevated performances.

The sophisticated concept fulfils the user's high expectations of optimum quality, high insulation and ease of operation. The system gives a lot of design freedom by allowing very large dimensions up to 3 meters in height and up to a vent weight of 400 kg.

Thanks to the "High Insulation" upgrade, the system can achieve superior insulation levels down to $1.07 \text{ W/m}^2\text{K}$ (Uf value). This results in a glazed element with insulation values lower than $1.0 \text{ W/m}^2\text{K}$, allowing the CP 155-HI system, which is certified with a Minergie label, to be used for low energy buildings.

Furthermore, the system is available with a low threshold that creates a perfect continuity between the indoor and outdoor spaces and improves the accessibility to the building. This accessibility and comfort is further improved by the solutions for automatic opening.





INTERIOR & EXTERIOR BECOME ONE

A sliding door opens up a multitude of possibilities. Through a sliding door, the garden is incorporated into the interior of the house, fading the interior-, exterior border. This creates an extra feeling of space and generates more natural light within the home.

CP 155 SLIDE AND CP 155 LIFT & SLIDE

All types of CP 155 sliding door use durable wheels and stainless steel rails, for optimal opening comfort. In case of a Lift & Slide system, the sliding door will be lifted up before sliding across this rail. In the closed position, the lift & slide door is put down and anchored, which is an extra plus for isolation and theft prevention. Both systems are completely wind-, waterproof and hermetically sealed.

MONORAIL, DUO RAIL OR 3-RAIL

A **monorail** combines a moving part with a fixed glazed element, anchored directly into the outer frame profile, creating a minimalistic look. As a standard, this solid part is at the inside of the sliding door. Yet for specific situations, a solution is offered in CP 155 to install the fixed part at the outside of the sliding door. This can be very convenient when large fixed glass panes need to be installed at elevated height or when building construction does not allow inside glazing.

MONORAIL	CP 155 / CP 155-HI	CP 155-LS / CP 155-LS/HI	CP 155-LS/HI WITH MINERGIE LABEL
	X	X	X

A **duo rail** integrates 2 glazed opening vents, which have an identical look resulting in an aesthetic sliding door. Both these vents can be made as sliding element, giving all flexibility to the users.

DUO RAIL	CP 155 / CP 155-HI	CP 155-LS / CP 155-LS/HI	CP 155-LS/HI WITH MINERGIE LABEL
	X	X	

A **3-rail** integrates an extra rail in the outer frame allowing a third opening vent to be installed. This solution is very interesting because this allows the user to open-up 2 sliding doors, creating an opening which is doubled in size.

3-RAIL	CP 155 / CP 155-HI	CP 155-LS / CP 155-LS/HI	CP 155-LS/HI WITH MINERGIE LABEL
	X	X	

TECHNICAL CHARACTERISTICS

Variants		CP 155 / CP 155-HI	CP 155-LS / CP 155-LS/HI	CP 155-LS/HI WITH MINERGIE LABEL
Visible width / height	Frame	52 mm	45 mm	60 mm
	Vent	102 mm	102 mm	102 mm
	T-profile	from 76 mm till 154 mm	from 76 mm till 154 mm	from 76 mm till 154 mm
	Meeting section	115 mm	115 mm	115 mm
	Threshold	60 mm	20 mm	69 mm
	Meeting section 4 doors	212 mm	212 mm	n/a
Overall system depth	Frame	155 mm / 242 mm (3-rail)	155 mm / 242 mm (3-rail)	192 mm
	Vent	68 mm	68 mm	68 mm / 105 mm
Maximal Element height		3000 mm	3000 mm	3000 mm
Maximal vent weight		300 Kg	400 Kg	400 Kg
Rebate height		25 mm	25 mm	25 mm
Glass thickness		up to 52 mm	up to 52 mm	up to 61 mm
Glazing method		dry glazing with EPDM or neutral silicones	dry glazing with EPDM or neutral silicones	dry glazing with EPDM or neutral silicones
Thermal insulation		32 mm and 23 mm fibreglass reinforced polyamide strips with 3 chambers	32 mm and 23 mm fibreglass reinforced polyamide strips with 3 chambers	41 mm and 23 mm fibreglass reinforced polyamide strips with 3 chambers
HI variant		extra insulation gaskets	extra insulation gaskets	standard available

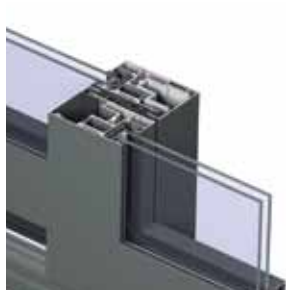

Slim Line middle section









CP 155-LS/HI low threshold



CP 155-LS/HI with Minergie label

PERFORMANCES

ENERGY												
	Thermal Insulation ⁽¹⁾ EN ISO 10077-2	Uf-value up to 1.07 W/m ² (*), depending on the frame/vent combination.										
COMFORT												
	Acoustic performance ⁽²⁾ EN ISO 140-3; EN ISO 717-1	Rw (C; Ctr) = 35 (-2;-5) dB / 42 (-1;-3) dB, depending on glazing type										
	Air tightness, max. test pressure ⁽³⁾ EN 12207	1 (150 Pa)		2 (300 Pa)		3 (600 Pa)		4 (600 Pa)				
	Water tightness ⁽⁴⁾ EN 12208	1A (0 Pa)	2A (50 Pa)	3A (100 Pa)	4A (150 Pa)	5A (200 Pa)	6A (250 Pa)	7A (300 Pa)	8A (450 Pa)	9A (600 Pa)	E900 (900 Pa)	
	Wind load resistance, max. test pressure ⁽⁵⁾ EN 12211; EN 12210	1 (400 Pa)		2 (800 Pa)		3 (1200 Pa)		4 (1600 Pa)		5 (2000 Pa)		
	Wind load resistance to frontal deflection EN 12211; EN 12210	A (≤ 1/150)			B (≤ 1/200)			C (≤ 1/300)				
SAFETY												
	Burglar resistance ⁽⁶⁾ ENV 1627 - ENV 1630	WK 1			WK 2				WK 3			

This table shows classes and values of performances, which can be achieved for specific configurations and opening types.

- (1) The Uf-value measures the heat flow. The lower the Uf-value, the better the thermal insulation of the frame.
- (2) The sound reduction index (Rw) measures the capacity of the sound reduction performance of the frame and glass.
- (3) The air tightness test measures the volume of air that would pass through a closed window at a certain air pressure.
- (4) The water tightness testing involves applying a uniform water spray at increasing air pressure until water penetrates the window.
- (5) The wind load resistance is a measure of the profile's structural strength and is tested by applying increasing levels of air pressure to simulate the wind force.
- (6) The burglar resistance is tested by static and dynamic loads, as well as by simulated attempts to break in using specified tools. This variant requires specific burglar resistance accessories.

(*) Value for HI-variant with Minergie label

MINERGIE®

Minergie is a sustainability label for new and refurbished buildings, with a focus on a high level of comfort in the building. To obtain this comfort level, the Minergie standards require high-grade, air-tight building envelopes and the continuous renewal of air in the building using an energy-efficient ventilation system. This Swiss Minergie standard is widely accepted and is referred to as a quality label.

Next to the building label, the Minergie label can also be awarded to building components like window-, door and sliding systems, based on specific low energy requirements.

Different Reynaers' systems are rewarded with this Minergie label: CP 155-LS/HI, CS 77 and CS 86-HV, offering a complete solution for the building.



REYNAERS ALUMINIUM NV/SA • www.reynaers.com • info@reynaers.com
11/2011 - 0H0.23D2.00 - Publisher Responsible at Law: Els Fonteyne, Oude Liersebaan 266, B-2570 Duffel

TOGETHER FOR BETTER

R
REYNAERS
aluminium

